

THASE®

Overhead Holders & Stops (Concealed Type) 39 Series – Medium duty

The 39 Series provides the various functions and finishes of the concealed overhead door holders to fit all standard interior applications.

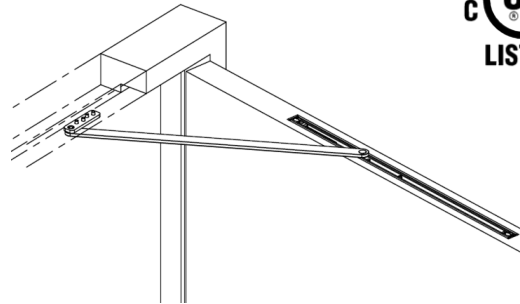

Description

- Recommend for the moderate traffic, medium weight interior doors
- Stop-only units are permitted on many fire door applications.
- When use with the surface mounted door closer, set the overhead door holder earlier than the door closer.
- Hold-open device cannot be used on the fire doors.
- Complete screw packet kit for installation in wood or metal door and frame.
- 3/4" (19mm) square channel
- Main material of channel and arm: Steel or Stainless steel
- Each model is available in 5 sizes. (Except when using the center hung)

Models

- 390H Series / Hold-open model
- 390S Series / Stop-only model
- 390F Series / Friction hold-open model

Features

- Non-handed
- Simple, durable and easy installation
- Slide track design
- Opening range: 85° to 110°
- For single or double acting doors
- The holder is completely concealed when the door is closed.





Finish

- US3, US4, US10, US10B, US20A, US28, US32, US32D

Certification

- Conform to UL 10C fire label A for 3-hour fire rating

Screw packet kit

Mounting Screw Details			
	Q'ty	Wood	Metal
Door	2	3/16 x 1-1/2"	#10 - 32 x 1-1/2"
			
Jamb	4	3/16 x 1-1/2"	#10 - 32 x 1/2"
			

Model No. and Door Opening Chart

Size	Butts/Offset Pivots				Center Hung			
	Door opening	Stop only	Hold open	Friction	Door opening	Stop only	Hold open	Friction
1	18"-23"	391S	391H	391F	-	-	-	-
2	23-1/16" - 27"	392S	392H	392F	-	-	-	-
3	27-1/16" - 33"	393S	393H	393F	33-1/16" - 39"	393S	393H	393F
4	33-1/16" - 39"	394S	394H	394F	39-1/16" - 45"	394S	394H	394F
5	39-1/16" - 45"	395S	395H	395F	45-1/16" - 51"	395S	395H	395F

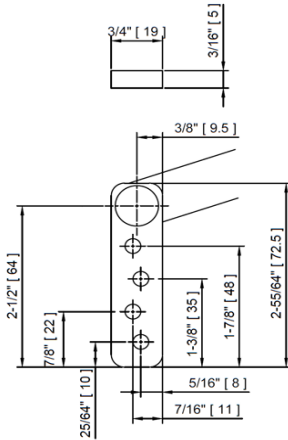

Jamb Bracket

*Dimensions in [] are millimeters.

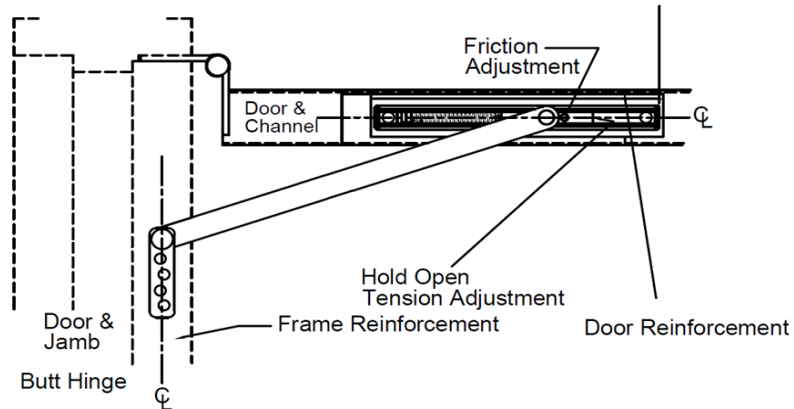

39 Series

Plan Mounting Top View

How to Order

39 2 H - US32D

Series Number

29 = Surface Overhead Door Holder

39 = Concealed Overhead Door Holder

Size code (Using butts/offset pivots of door opening chart)

1 = 18"~23"

2 = 23-1/16" ~ 27"

3 = 27-1/16" ~ 33"

4 = 33-1/16" ~ 39"

5 = 39-1/16" ~ 45"

Function No.

S = Stop only

H = Hold open

F = Friction

Finish color

US3 or **605**

US26D or **626**

US32D or **630**